



IRCLASS
Indian Register of Shipping

Issue 5 - Sept 2023

TOUCH OF CLASS





C O N T E N T S

Message from the Executive Chairman's Desk	02
Managing Director's Message	03
From the Editorial Board	04
ESG: A Strategic Approach for Shipping Decarbonisation	05
Numerical prediction of resistance for High-Speed Crafts (HSC)	08
Hong Kong Convention (HKC)	12
IRClassTM	14
ISSPL - Civil NDT & Structural Condition Assessment Services	16
Key Press Releases	19
Events, Webinars & Conferences	20
Vessels - Classed, Launched & Delivered	24
Training	25
Academy	27
Employee Corner	29

MESSAGE FROM THE EXECUTIVE CHAIRMAN'S DESK



Dear Readers

Decarbonisation goals and ambitions have opened new avenues, including development of design, construction, logistics and energy in maritime industry. New technologies would require to be evaluated and compared from various perspectives, not only technical factors but also economic, geopolitical and social factors. This multi-solution approach requires collection of data, which can be analysed to create holistic solutions, encompassing all aspects of maritime sector. Digitalisation plays a vital role towards collecting and analysing the quantum of data which comes along when dealing with these challenges. With this in mind, IRS has embarked on a digitalisation journey adopting the global best practices to appropriately aid stakeholders in the maritime fraternity.

Artificial Intelligence (AI) is slowly taking over repetitive jobs, which otherwise are a cause of fatigue. Benefits of AI can be utilised to tackle issues pertaining to human element. We all recognise that competent Human Element can reduce accidents significantly and utilising AI would improve safety of operations in all sectors. Employing AI in design, manufacturing and operations, across industries will usher efficiency and safety.

At IRS, we are focussing on training, upskilling, digitalisation, decarbonisation and human element collectively to ensure transformation towards a clean, sustainable and safe future. I wish the readers a happy reading!

MANAGING DIRECTOR'S MESSAGE



Dear Readers

At MEPC 80, the revised IMO GHG strategy was adopted, significantly elevating the level of ambition and introducing checkpoints with the aim to effectively reduce greenhouse gas (GHG) emissions. The revised IMO GHG strategy now explicitly addresses life cycle GHG emissions which acknowledges and encompasses emissions throughout the entire life cycle of shipping, including fuel production and transportation and encourages adoption of measures that effectively mitigate emissions. With the adoption of revised GHG Strategy we've leaped from a 50% reduction in GHG emissions by 2050 to a stronger ambition of net-zero GHG emissions by 2050. With intermediate checkpoints also marked, the industry's march towards decarbonisation is clear, which requires all stakeholders to continually strive in achieving the new goals.

This necessitates a shift from the conventional decisions and options to choose the path which significantly reduces GHG emissions. In this endeavour, experience gained by operators utilising alternate means, including use of biofuels, fitment of energy saving devices and application of improved coating systems, may act as vital leads. IRS can assess the proposals made by operators and submitted for verification using various techniques including CFD Analysis.

IRS is progressively looking at improving its systems by employing digital technology to make its processes smarter and more efficient. Initiatives are being taken with the use of advanced digital tools to better serve its clients. IRS' collaboration with Dassault Systems to leverage technology will surely drive digital transformation and further boost operational efficiency. It is envisaged that it will enable IRS to enhance and implement data driven decision making, concept design, engineering, integrated operations and maintenance processes.

With the increase in the fleet under IRS class and consequent addition of resources, IRS is training Surveyors to ensure that they are qualified. Further, training programmes are being conducted towards upskilling for new requirements and developments in the maritime sector as a result of decarbonisation including new fuels, technologies and digital tools, to provide efficient services globally.

Wishing the readers a pleasant reading!



FROM THE EDITORIAL BOARD

Dear Reader,

We are delighted to present to you this latest edition of Touch of Class. As in the recent past, we have put together a diverse range of technical and topical articles.

The maritime fraternity will soon be celebrating World Maritime Day and this year's theme is "MARPOL at 50 – Our commitment goes on". It reflects the shipping industry's strong resolve to protect the marine environment and emphasises its continual commitment to sustainability.

MEPC 80 recently adopted the revised strategy for reduction of GHG emissions from international shipping. As the levels of ambitions are set higher, the industry is looking at several options to meet them. One such strategy based on Environmental, Social and Governance (ESG) principles has been put forth in one of the articles.

An article on numerical prediction of resistance for High-Speed Crafts (HSC) using CFD Analysis adds a more technical flavour to the edition which can be a useful tool for the designers and shipbuilders at the initial design and the construction phase to arrive at the powering requirements.

After the recent ratification by Bangladesh and Liberia; the Hong Kong International Convention

for the Safe and Environmentally Sound Recycling of Ships (HKC) will finally be entering into force on 26th June 2025, after more than a decade of getting adopted. Important timelines and action plans for shipowners and IRS services are showcased in our piece on the HKC.

Thickness measurement plays a vital role in the maintenance and survey of a vessel. Information about our application IRClass™ for generating Thickness Measurements Reports for Classification Surveys and Condition Assessment Program Reports is presented.

An overview is provided regarding the various civil NDT and structural condition assessment services offered by IRClass Systems & Solutions Pvt. Ltd. (ISSPL).

Along with these topics, readers will also get an insight into some of the key events and developments at IRS.

We hope that you will find this edition of Touch of Class interesting and would be glad to receive your feedback on toc@irclass.org.

ESG: A STRATEGIC APPROACH FOR SHIPPING DECARBONISATION

Dr. Suhas Vhanmane
Principal Surveyor
Strategic Research, RDAREA



In 2018, at the 72nd Session of the Marine Environment Protection Committee (MEPC) and through Resolution MEPC 304(72), the International Maritime Organisation (IMO) adopted an initial strategy for the reduction of GHG emissions from ships, setting out a vision that strengthened IMO's commitment (as shown in Figure 1c) to reduce GHG emissions from international shipping and to phase them out as soon as possible.

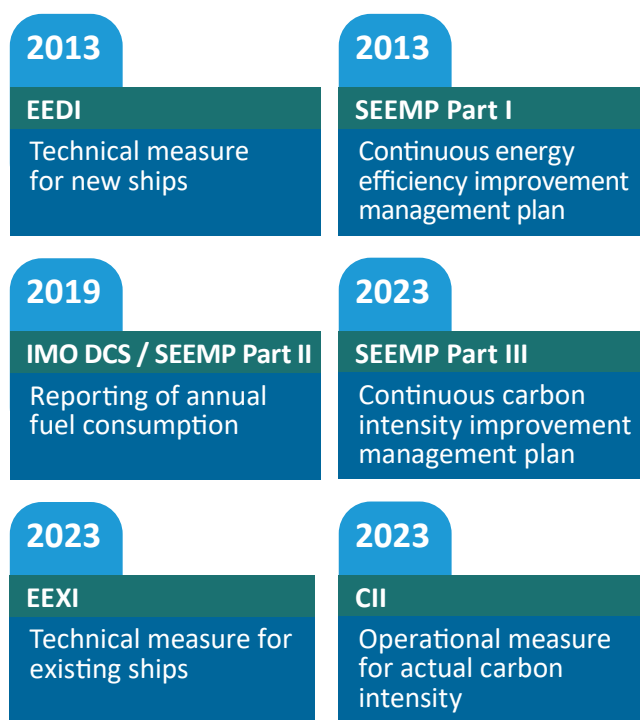
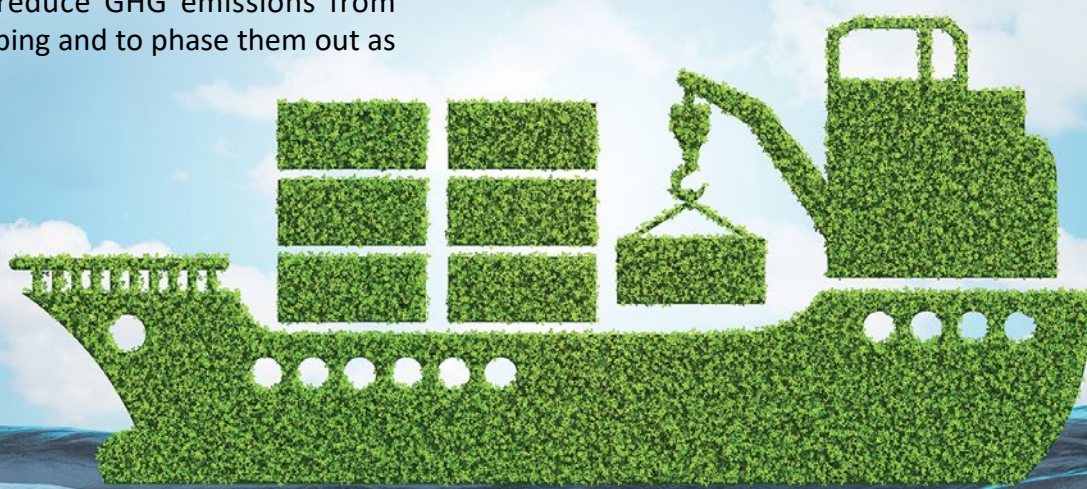

Recently in July 2023, the International Maritime Organisation (IMO) Marine Environment Protection Committee (MEPC) held its 80th session. MEPC 80, accounting for the extensive discussions, approved the 2023 IMO Strategy on Reduction of GHG Emissions from Ships through Resolution MEPC.377 (80). The 2023 IMO GHG Strategy increases the levels of ambition compared to the Initial IMO Strategy on the Reduction of GHG Emissions from Ships considering the Well-to-Wake (WtW) GHG emissions of marine fuels.

The 2023 IMO GHG Strategy is directed by the following levels of ambition:

- To reduce CO₂ emissions per transport work, as an average across international shipping, by at least 40% by 2030, compared to 2008
- Uptake of zero or near-zero GHG emission technologies, fuels and/or energy sources to represent at least 5%, striving for 10%, of the energy used by international shipping by 2030

Figure 1. IMO requirements towards decarbonisation of shipping

- To peak GHG emissions from international shipping as soon as possible and
- To reach net-zero GHG emissions by or around, i.e. close to 2050, whilst pursuing efforts towards phasing them out as called

for in the Vision consistent with the long-term temperature goal (limiting global temperature increase to well below 2 °C, while pursuing efforts to limit the increase to 1.5 °C) set out in Article 2 of the Paris Agreement.

Above ambition levels are accompanied with following checkpoints to reach net-zero GHG emissions from international shipping:

- To reduce the total annual GHG emissions from international shipping by at least 20%, striving for 30% by 2030, compared to 2008.
- To reduce the total annual GHG emissions from international shipping by at least 70%, striving for 80% by 2040, compared to 2008.

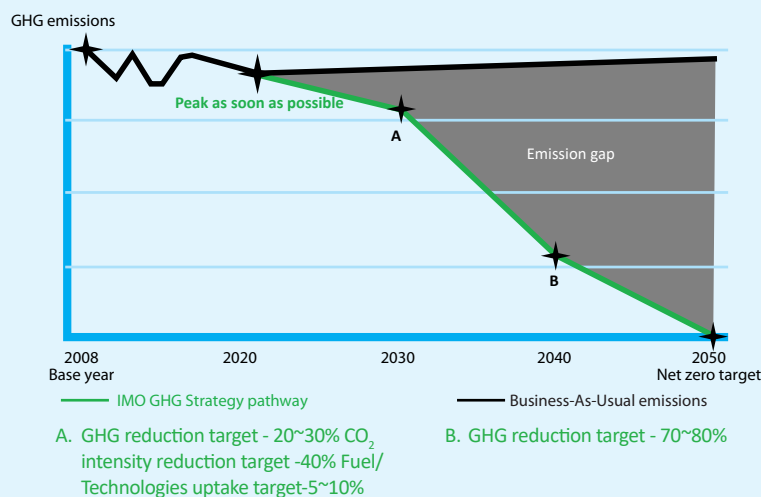

Figure 2. The 2023 IMO GHG Strategy

Though shipping currently accounts for 2.3% of global CO₂ emissions, meeting the ambitious levels of decarbonisation set out by the 2023 IMO GHG Strategy is going to be a challenging task. To tackle this challenge, along with the ship designers, owner/manager, other stakeholders including time charterers, shipyards, terminals and bunker suppliers of the shipping supply chain need to identify their roles and act effectively.

As we know, with the entry into force of revised MARPOL Annex VI, all sea-going vessels of greater than 5,000 GT, should have a SEEMP Part III prepared with a three-year implementation

plan to achieve the required operational annual carbon intensity indicator (CII) value. Based on the attained and required CII value, those vessels will be ranked in the A to E class categories. The required CII value will be reduced annually, leading to a continuous ranking deterioration if no countermeasures for emissions reduction are applied.

To understand the practical challenge, we refer to an actual CII performance case of a Tanker of 74000 DWT size as shown in Figure 3. Target CII reduction in the next three years by 2025 is 21 % which is a mammoth challenge for this ship.

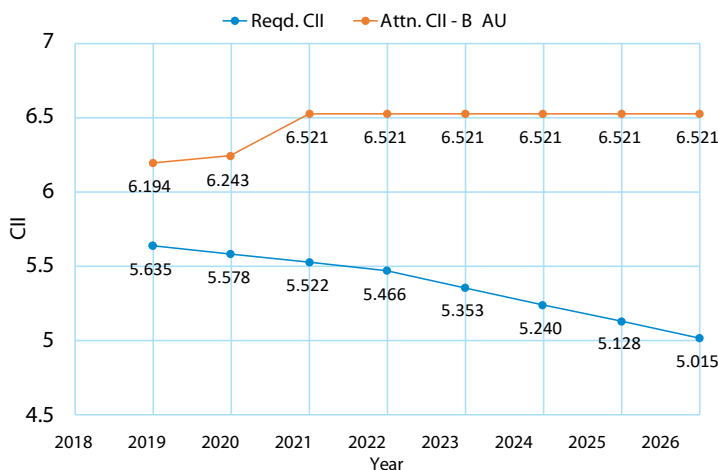

Figure 3. CII performance of a Tanker

In such a case, a strategic approach of ESG (Environmental, Social and Governance) principles can play a vital role as new regulations are pushing the shipping sector to prioritise sustainability. It is apparent that sustainability is increasingly becoming a license to operate in the future and environmental compliance pressure is building on ship owners and operators from customers, regulators, investors, insurers and other stakeholders.

Indian Register of Shipping understands the changing environmental compliance and its impact on the shipping business landscape and considers that the time has come for the shipping industry to embark on the ESG journey though it is new to the shipping industry. We strongly believe that a successful decarbonisation strategy is closely related to a comprehensive ESG strategy with ambitious target setting across E, S, and G involving ships, technology and people. ESG, a strategic approach, involves setting clear targets, developing roadmaps for meeting targets, and reporting progress. It has the potential to drive climate action and more sustainable behaviour, including, but not limited to reducing GHG emissions by improving the reliability, comparability, and transparency of organisational ambitions and actions thus ensuring organizational readiness for the landscape of sustainability.

While we embark on the ESG strategy, it should be noted that it is not one entity's responsibility. It requires a mindset focusing on collective actions across the shipping supply chain as indicated in Figure 4.



The specific elements characterize a solid and credible ESG strategy:

- Set time-bound long-term and ambitious ESG commitments with interim targets.
- Develop a strategy for how to achieve targets.
- Invest in initiatives and governance.
- Track progress and report using a global standard.

As there are no global standards for the shipping sector, other globally recognised standards such as SASB (The Sustainability Accounting Standards Board), GRI (The Global Reporting Initiative), CDP (Carbon Disclosure Project), and TCFD (Task Force on Climate-related Financial Disclosures) may be used as guidance.

For shipping, an example of a decarbonisation ESG strategy is described below.



- Target:** reduction of GHG emissions (scope 1 / scope 2 / scope 3)
Action: The vessel owner commits to net zero targets and invests accordingly in efficiency technology and future fuels to reduce CO₂ emissions.
- Target:** Upskilling/reskilling of people involved
Action: need to up or reskill seafarers to ensure safe and accurate operations are identified and planned for implementation.
- Target:** Review of actions using data
Action: Transparency in data documenting, annual progress on emission reductions shared with customers and investors – and made publicly available.

To conclude, the ESG Strategic framework is a useful tool for the shipping industry to consider, as we deal with the challenge of decarbonising shipping.

NUMERICAL PREDICTION OF RESISTANCE FOR HIGH-SPEED CRAFTS (HSC)

Reliable prediction of resistance is always required for deciding the suitable engine for the vessel. Empirical methods for resistance prediction are traditionally used at the initial design stage. Those are well established for displacement vessels and a few forms of fast vessels. At a later stage of the design, model testing is implemented for accurate resistance predictions and possible hull form changes to meet powering requirements. In the case of High-Speed Crafts (HSC), the validity of the empirically estimated resistance can be questionable. Further, very few methods can be applicable for multi-hull vessels; wherein numerical techniques

can be advantageously utilised for resistance predictions and hull form optimization. Numerical predictions can be particularly useful when engines are pre-decided due to commercial constraints for small HSCs. Design challenges such as resolving free surface for high-speed case and hydrodynamic interaction between hulls of multi-hull vessels during numerical predictions are discussed in this article.

Mr. J Ramkumar
Sr. Surveyor
R&D



Mr. K Srinivas
Surveyor
R&D



Resistance Estimation based on Empirical Methods and Model Testing

The initial estimate of the vessel's resistance can be arrived at based on certain empirical methods, based on regression analysis of methodical series test data like the VPS, VWC & VWS (Fig.1) hull forms where 'V' is short for deep-V type, 'P' and 'W' are short for planning and wave-piercing respectively, and 'S' and 'C' stand for straight and concave section shape hull models respectively.

Some of the frequently used prediction methods are those of Mercier and Stavisky (1973), Fung (1991) and Lathiharju (1991) which provide an excellent means by which a designer can predict the resistance for an HSC. The details of a few methods and their limitations are tabulated in Table 1. Other parameters such as volumetric Froude number, deadrise angle amidships, angle of entrance, transom wedge, etc. are also accounted for in a few of these methods.

Table 1. Applicability of Statistical Methods for Resistance Estimation based on Vessel parameters

Parameters	Savitsky Pre-Planning '73	VWS Hard Chine '89	Schwetz and Sahoo (2002)
L/B(Demi)	7-15.1	7.55-13.55	8.8-15.0
L/(\Delta^{1/3})	6.27-9.5		6.30-19.56
B/T	1.5-2.5		1.47-2.31
CB	0.397		0.46-0.68
s/L		0.167	
Type of Hull form	NPL Round Bilge	Chine	Round-Bilge, Semi Swath and Chine

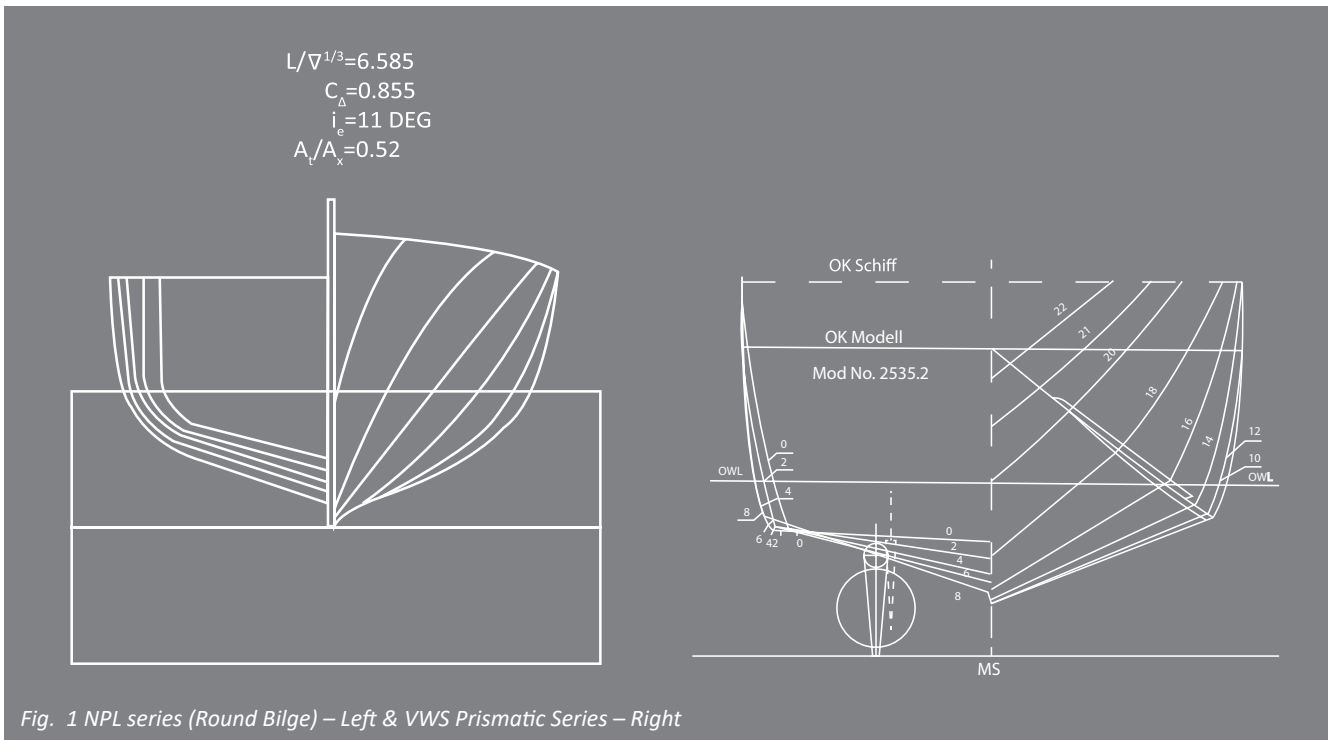

Fig. 1 NPL series (Round Bilge) – Left & VWS Prismatic Series – Right

The accuracy of the resulting prediction is likely to be good, provided that the designed vessel is of similar form to that of the series of models tested. However, if the principal parameters of the vessel to be designed fall outside the limits of applicability of the prediction method, then the resulting prediction can be grossly inaccurate.

Another alternative to arrive at accurate resistance is by performing model testing. The testing procedures and scaling of the results from model scale to full scale are well established for displacement hulls, while for high-speed crafts experiments to determine the resistance requires suitably large facilities and a careful selection of test procedures. In the case of High-Speed Crafts, the dimensionless numbers characterising the physics of the flow are the Froude number, the Reynolds number and the Weber number which are generally used for scaling model test results. The Froude number describes the effect

of gravity on the water surface. The Reynolds number relates the inertial forces to viscous forces and the Weber number relates the inertial forces due to surface tension. Conservation of all these three dimensionless numbers is not feasible as a model scale hull with a shorter length will have a lower speed to conserve the Froude number but a higher speed to preserve the Reynolds and Weber numbers. The established solution to this problem is to use the same Froude number in the model tests and to account for the different Reynolds numbers in the scaling process. The difference in Weber number between model scale and full-scale causes errors in the predictions of water spray and wave pattern which are insignificant for displacement hull and for lower speeds of HSC. However, in the case of planing hulls the effects of water spray and wave-hull surface interactions in a catamaran are significant.

Application of CFD

With the recent advancements in numerical methods and computational resources, Computational Fluid Dynamics (CFD) offers a promising choice to arrive at a resistance estimate for HSC. The free surface is resolved to the possible accuracy for predicting the resistance of the vessel. Sample plots of free surface for a given vessel (HSC) speed are shown in Fig. 2.

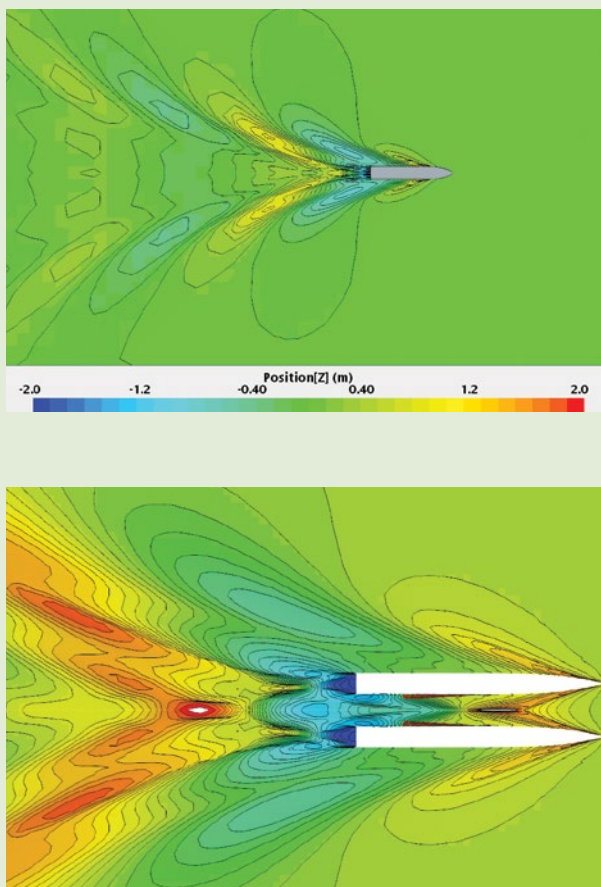

Fig. 2 Wave Contour for HSC (Left) and Catamaran (Right) using CFD

A Numerical Wave Tank (NWT) is modelled which solves Reynolds Averaged Navier-Stokes Equations (RANSE) in the computational domain to solve for the flow fields. In the case of high-speed crafts operating at higher Froude numbers (planing regime), the dynamic lift is generated by the hull which reduces the wetted surface area allowing the craft to achieve higher speeds with

relatively less coefficient of frictional resistance. This dynamic lift is obtained by the use/varying of different geometrical features like deadrise angle, spray rails, chine, tunnel and stern wedge (Fig. 3). Effect of change in resistance due to change in the location, placement and orientation of geometrical features can be estimated using CFD.

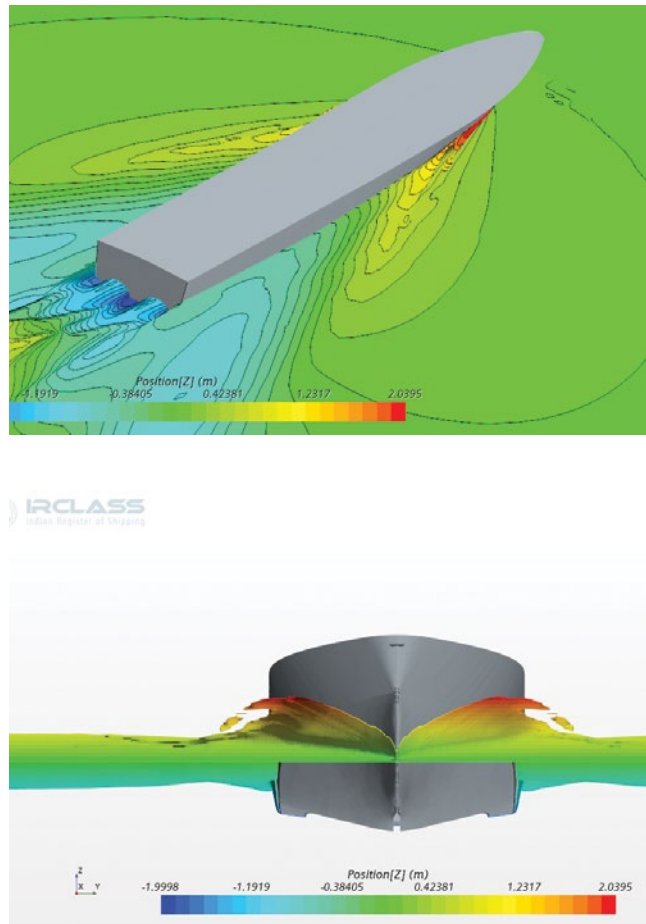
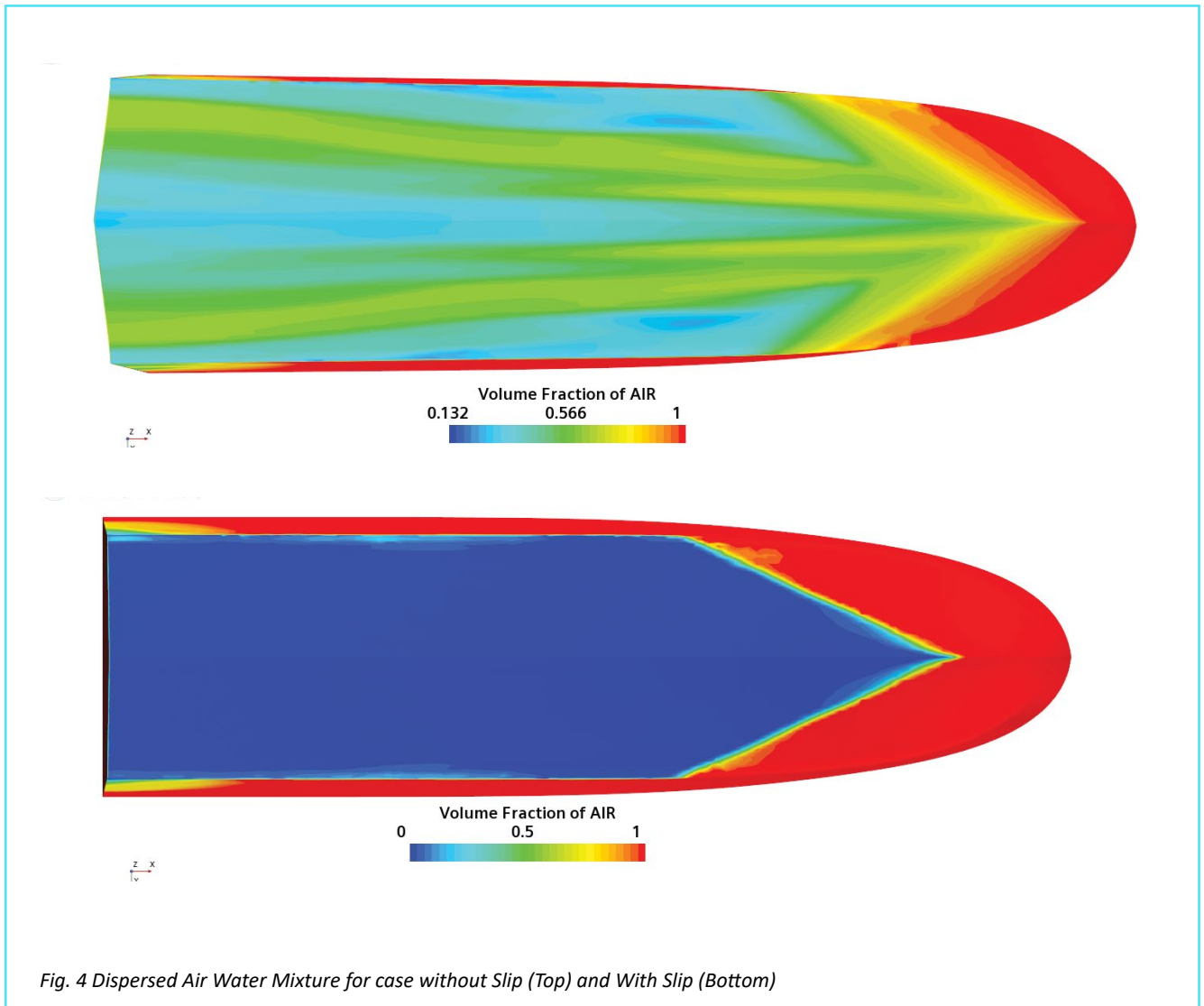

Fig. 3 Free-Surface Contour for HSC in the presence of Shaft Tunnel (Left) and Wave Spray (Right)

IRS has developed best practices and established a procedure for numerical modelling of wave tanks and resistance estimation of HSC. Challenges like numerical ventilation, which generally occur at higher speeds when there is the mixing of two different phases air and water have been accounted. A method using modified High-Resolution Interface Capturing (HRIC) is adopted by enabling slip velocity in the phase-interaction model. This model acts by algebraically computing the different velocities for the two phases (air & water) when they co-exist allowing the air to separate from the water, thus recovering the interface (Fig. 4).



Using the concept of slip velocity several validation studies are performed for standard hull forms to evaluate the resistance at lower speed and at higher speeds when the vessel enters into the planning regime. The limitations of applicability of empirical methods due to a change in hull form can be mitigated using

CFD. CFD can also be used in the early stages of design evaluation of the hull form towards reduction in resistance by varying geometrical features like spray rails, chine, tunnel and stern wedge relatively in a shorter time frame with fewer overheads and budgetary requirements meeting the project costing.

Concluding Remarks

The resistance of an HSC varies drastically with the slight change in displacement. Any increase in displacement during the construction phase may lead to a change in resistance affecting the powering requirements. CFD-based numerical assessment can be utilised not only at the initial design but also at the construction phase to arrive

at the powering requirements and estimate the attainable speed for the change in displacement. Investigations with respect to various retrofitting/appendages such as trim wedge and spray rails can be made utilizing CFD techniques to assess the effect on the achievable speed.

Note: In the previous edition, the utilisation of CFD towards HSC was discussed which can be obtained from our website or on request.

HONG KONG CONVENTION (HKC)

Adopted in 2009, IMO's Hong Kong International Convention for Safe and Environmentally Sound Recycling of Ships (also known as 'Hong Kong Convention', 'HKC'), was ratified on 26th June 2023 and is set to enter into force on 26th June 2025.

The Hong Kong Convention was adopted at a diplomatic conference held in Hong Kong, China, in 2009. It is aimed at ensuring that ships, when being recycled at the end of their operational lives; do not pose unnecessary risks to human health, safety and the environment. HKC embraces the "cradle to grave" concept, addressing all environmental and safety aspects relating to ship recycling, including the responsible management and disposal of associated waste streams in a safe and environmentally sound manner.

Mr. Amol Bande
Senior Surveyor
Ships & Technical Services



The HKC has requirements that encompass various aspects of ships such as design, construction, survey, certification, operation, inspection and recycling, thereby placing responsibilities and obligations on all concerned stakeholders including Flag Administrations, ship-owners, shipbuilding yards, ship recycling facilities, port states and recycling states for implementation and compliance.

Upon entry into force of the Hong Kong Convention, ships to be recycled are required to carry onboard an Inventory of Hazardous Materials, supplemented with an International Certificate on Inventory of Hazardous Materials. Ship recycling facilities, authorised by Competent Authorities, will be required to provide a Ship Recycling Plan, specific to each individual vessel to be recycled. Additionally, recycling states will be required to ensure that recycling facilities under their jurisdiction comply with the Convention.



APPLICABILITY

HKC is applicable to all ships (both New Build and Existing) of more than 500 GT and flying the flag of a country that is party to the convention excluding naval and governmental non-commercial ships or ships operating within the jurisdiction of flag state.

HKC is also applicable to Ship Recycling Facilities operating under the jurisdiction of a party to the convention.

TIMELINE OF APPLICATION

New Ships

The applicability for new ships is as follows:

- i. For which the building contract is placed on or after 26th June 2025
- ii. In the absence of a building contract, the keel of which is laid or which is at a similar stage of construction on or after 26th December 2025 or
- iii. The delivery of which is on or after 26th December 2027

Existing Ships

Existing ships to which HKC applies will be required to comply with the convention by 26th June 2025 but not later than 25th June 2030 or before going for recycling, whichever is earlier.

Ship Recycling Facility (SRF)

Ship Recycling Facilities are required to comply with HKC by 26th June 2025. Ships heading for recycling will be required to be recycled in a facility which is:

- a. Duly authorised in accordance with the Convention and
- b. Undertakes all the recycling in accordance with the approved Ship Specific Recycling Plan (SRP) prepared by the identified Ship Recycling Facility (SRF)

REQUIREMENTS

Ships

Subsequent to entry into force of HKC:

- a. All applicable ships will be required to have a valid Inventory of Hazardous Materials (IHM) placed onboard, supplemented with a valid International Certificate on Inventory of Hazardous Materials (ICIHM) showing evidence that the ship has implemented controls on the use of hazardous materials as identified in HKC.
- b. IHM is prepared in accordance with the guidelines MEPC.379(80).
- c. Part I IHM is maintained and updated throughout the operational life of the ship, reflecting new installations containing Hazardous Materials and relevant changes in ship structure and equipment.
- d. Prior to recycling, the IHM in addition to the properly maintained and updated Part I, incorporates Part II for operationally generated wastes and Part III for stores supplemented with a valid International Ready for Recycling Certificate (IRRC).
- e. In the period, prior to entering the Ship Recycling Facility, conduct operations in such a way as to minimize the amount of cargo residues, remaining fuel oil, and wastes remaining on board.
- f. Arrive at the Ship Recycling Facility, with cargo tanks and pump room(s) in a condition that is ready for certification as Safe-for-entry, Safe-for-hot work, or both, in the case of a tanker.
- g. Provide to the Ship Recycling Facility all available information relating to the ship for the development of the Ship Recycling Plan.

- h. Ships will be subject to survey and certification by the Flag Administration or its RO and also subjected to inspection by port state and flag state.

Ship Recycling Facility (SRF)

In order to be an authorised Ship Recycling Facility, each SRF will be required to be designed, constructed, and operated in a safe and environmentally sound manner in accordance with the Convention.

SRF will be required to establish management systems, procedures and techniques that do not pose health risks to the workers concerned or to the population in the vicinity of the Ship Recycling Facility and which will prevent, reduce, minimize and to the extent practicable eliminate adverse effects on the environment caused by Ship Recycling.

Subsequent to entry into force, the Ship Recycling Facility will:

- a. Only accept ships that comply and meet the requirements of HKC
- b. Only accept ships which they are authorised to recycle and
- c. Have the Documentation of its Authorization on Ship Recycling (DASR)

IRS Services for the Stakeholders

The stakeholders involved in the implementation of HKC are required to update and augment their systems and procedures as relevant to their role and responsibility. IRS, with its vast experience in the implementation of new requirements and being a reliable partner in the maritime industry, is ready to offer the necessary handholding and assistance to its clients.

Currently, IRS is engaged in various services such as Hazardous Material Expert Certification Training, Approval of Service Suppliers engaged in preparation of IHM, Survey and Certification of New build and Existing ships, Certification of Ship Recycling Facility, Training programs for shipyards and ship owners.

Considering the large number of ships requiring HKC compliance including new building yards and ship recycling facilities, it is strongly recommended that shipbuilders, owners, managers and ship recyclers become aware and familiarize themselves with the HKC requirements. IRS has the capability and professional knowledge to assist all interested clients. Clients are welcome to express their interest by writing to us.

IRClass™

Mr. Kripakar M Marur
Sr. Surveyor
Tech Soft. Development



IRClass™ is a solution designed to document Thickness Measurement surveys and ensure regulatory compliance. This software consists of two modules: the Classification Survey Module and the Condition Assessment Program (CAP) Module. In this article, we will explore the key features of both modules, including

standardised forms, multiple Rule types, Enhanced Survey Programme (ESP) support, automatic diminution calculations, visualization capabilities, integration with IR-LS&B, and auto-generation of reports.



CLASSIFICATION SURVEY MODULE

The Classification Survey Module of IRClass™ Thickness Measurement Software offers standardised forms that provide a uniform format for capturing thickness data, ensuring consistency and adherence to industry standards. The module supports multiple rule types, including IRS (Indian Register of Shipping) and Common Structural Rules (CSR). This flexibility enables users to meet various regulatory requirements, ensuring compliance across different vessel types and structures. The software is also capable of handling vessels under the Enhanced Survey Programme (ESP).

Automatic diminution calculations are a key feature of the Classification Survey Module. Based on vessel type and structure, the software performs calculations to determine the maximum allowable diminution. This automated process saves time and reduces the potential for errors. To facilitate the easy interpretation of diminution data, the Classification Survey Module provides visual cues by colour coding the strakes/stiffeners.

Authorization and deferment options are essential for maintaining data integrity and managing inspection workflows effectively. The Classification Survey Module includes authorization controls to enable IRS Surveyors to sign off on TM Reports. Deferment functionality allows Surveyors to defer repairs if a Renewal Survey is due for the vessel.

CONDITION ASSESSMENT PROGRAM (CAP) MODULE

The CAP Module is essential for calculating the CAP Rating of a vessel, which is a crucial requirement for charter parties. This module enables users to assess the condition of vessels accurately, considering factors such as structural integrity, maintenance history, and operational performance. The CAP Rating provides stakeholders with valuable insights for chartering decisions.

Compartment modelling and auto-generation of panels are integral to the CAP Module. Users can create virtual compartment models. The module automatically generates panels based on these compartments for which thickness data is to be gauged and recorded.

Auto job card generation simplifies the rating process for Surveyors. The module generates job cards with predefined inspection criteria, facilitating visual inspections and recording of relevant data. This automation ensures consistency and accuracy in the assessment, streamlining the Surveyor's workflow.

An intuitive interface is provided for recording thickness data, making data entry user-friendly and efficient. The module simplifies the process of capturing and managing thickness measurements, ensuring accurate and reliable data for assessment purposes.

Automatic generation of CAP reports is a key feature of the CAP Module. These reports include CAP Rating calculations, Panel Rating graphs, and Diminution S-Curves, providing a comprehensive overview of the vessel's condition. The CAP report assists in decision-making processes related to vessel maintenance and repair.

CONTACT INFORMATION

For further inquiries or support regarding IRClass™ Thickness Measurement Software, please contact the dedicated team at tm@irclass.org. Our experienced team is ready to assist you with any questions or concerns, ensuring a smooth and productive experience with our software.

CURRENT VERSION INFORMATION

The latest version of IRClass™ Thickness Measurement Software is v7.5.0, released on 26th June 2023. This version incorporates updates and enhancements based on user feedback, providing users with the most reliable and up-to-date solution.

SCREEN CAPTURES

No 2 Cargo Tank Stbd : TM5 - Stiffeners in Stool - Transverse Bulkhead - 71										
old Description	No 2 Cargo Tank Stbd									
n of Structure	Transverse Bulkhead @ Frame #71				Frame Number		Diminution S		Thickness as Renewed (mm)	
Structural Component	Original Thickness (mm)	Maximum Allowable Diminution (mm)	Gauged Thickness (mm)		Diminution P		Diminution S		P	S
			P	S	(mm)	%	(mm)	%		
S - 6 - Web	13.00	3.25	12.80	12.80	0.20	1.54	0.20	1.54		
S - 7 - Web	13.00	3.25	12.80	12.80	0.20	1.54	0.20	1.54		
S - 8 - Web	12.00	3.00	7.00	7.00	5.00	41.67	5.00	41.67	12.00	12.00
S - 8 - Flange	12.00	3.00	16.80	16.80	0.00	0.00	0.00	0.00		
S - 9 - Web	12.00	3.00	9.10	9.20	2.90	24.17	2.80	23.33	13.00	13.00
S - 9 - Flange	12.00	3.00	9.30	9.20	2.70	22.50	2.80	23.33	12.00	12.00
S - 10 - Web	12.00	3.00	11.80	11.80	0.20	1.67	0.20	1.67		
S - 10 - Flange	12.00	3.00	8.00	8.00	4.00	33.33	4.00	33.33	12.00	12.00
S - 1 - Web	17.00	4.25	12.20	12.30	4.80	28.24	4.70	27.65	17.00	17.00
S - 1 - Flange	17.00	4.25	19.80	19.80	0.00	0.00	0.00	0.00		
S - 2 - Web	12.00	3.00	11.80	11.80	0.20	1.67	0.20	1.67		
S - 3 - Web	12.00	3.00	6.00	7.00	6.00	50.00	5.00	41.67	12.00	12.00
S - 4 - Web	12.00	3.00	11.80	11.80	0.20	1.67	0.20	1.67		

Legend: Prompt Repairs (Purple), Excessive Diminution (Red), Substantial Corrosion (Orange), Rapidly Diminishing (Light Blue), Renewed As Built (Green), Renewed Less Than As Built (Brown), Renewed More Than As Built (Dark Blue)

Mr. Saiprasad Gaonkar
Sr. Manager
Industrial Services



CIVIL NDT & STRUCTURAL CONDITION ASSESSMENT SERVICES

The Maritime industry is responsible for the transportation of goods, products, and people by sea. The shipping industry transports more than 95% of global trade by volume-roughly 11 billion tons annually. Jetties are important structures in coastal facilities that provide safe berthing of vessels and host various Material Handling Equipment. Various parameters, such as severe exposure conditions, oceanographic conditions, salinity, ballast water contamination, wind velocity and its direction, affect the structural deterioration of jetty structures. Periodic inspections and repairs from an early age are crucial for maintaining healthy and safe structures.

ISSPL – Civil NDT Services assess the extent of distress by performing rigorous inspections and the most advanced NDT Techniques. Our NABL accreditation ensures the best Quality Testing in accordance with International Standards and with the state of the art equipment available in the Industry.

Detailed Inspection, study and analysis help to derive the most appropriate rehabilitation measures or repair methodologies to preserve structures.



Our Approach

1. Rigorous visual inspection of each and every member
2. State of the art Civil NDT (NABL Accredited)
3. In-depth analysis of the findings
4. Distress categorization & drawings for easy identification.
5. Techno-economical suggestions for the repairs & rehabilitation
6. Estimates for the repairs
7. Support during tendering & vendor evaluation.
8. Project management consultancy during repairs
9. Post repairs confirmation survey & quality check by NDT
10. Inspections of the fendering system & material handling equipment

List of Civil ND Tests for Marine Structures

- Ultrasonic Pulse Velocity testing
- Rebound hammer (Schmidt Hammer)
- Carbonation Test
- Half-cell potential meter measurements to determine corrosion probability
- Chloride Penetration Test
- Chemical Tests
- Cover Meter
- Core Test/ Capo Test for Concrete
- Concrete Electrical Resistivity Test
- Galvapulse Test for rate of corrosion
- Ultrasonic Thickness Testing for Pile liners & steel piles

ISSPL is proud to provide Condition Assessment services to various ports in India and some of the International Ports in Tanzania & Sri Lanka.

Typical Damages Observed in Jetty Structures



Corrosion of Sacrificial Liners & loss of strength in RCC elements

Post Repair



Restoration of RCC Elements
Corrosion treatment, concrete section built up & protective coating



Verifying Post grouting
Cracks are sealed after grouting

Post-repair achievement of structural performance. Quality assurance by strict supervision, Post-repair confirmatory survey & various tests

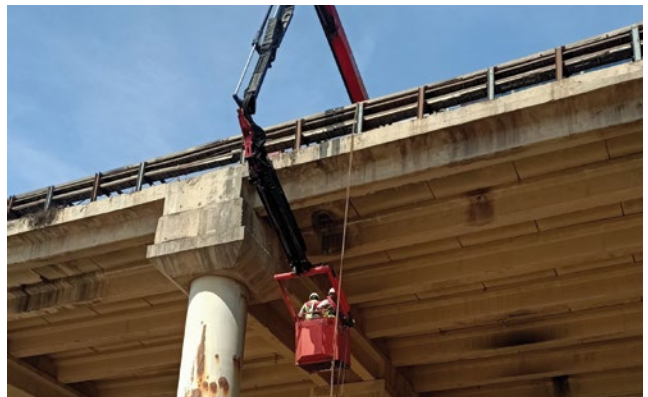

Onsite Inspections by experts for soffit by boat and by bridge inspection unit as per site requirements



Underwater inspection for Piles



NDT performed on-site professionally & with utmost safety

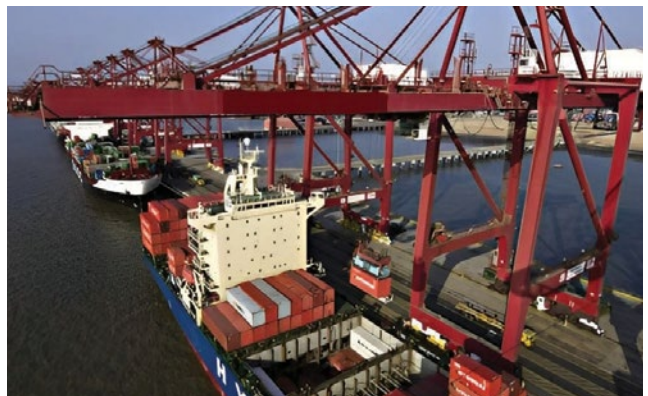
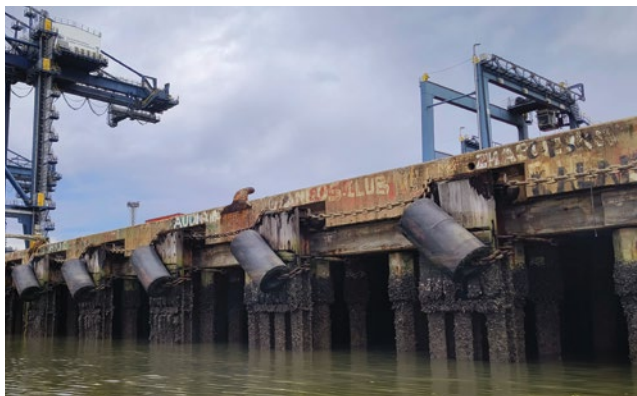

Survey for Fenders & Material Handling Equipment Condition Assessment

Key Press Releases



Honourable Minister Shri Sarbananda Sonowal visits the Indian Register of Shipping

Shri Sarbananda Sonowal, Union Cabinet Minister for Ports Shipping & Waterways and Minister of Ayush visited IRS Head Office, Mumbai on 25th May 2023 & reviewed the work being undertaken by the organisation. He lauded the green initiatives being taken by IRS in reducing GHG emissions towards meeting IMO climate goals & also interacted with the Rule and Research & Development team of the IRS to understand various aspects of research projects.



Indian Register of Shipping (IRS) named Classification Society of the Year at the 18th Shiptek International Maritime Awards

IRS has consistently demonstrated its commitment to ensuring the highest quality and reliability in its classification services by focusing on safety, compliance, and industry standards.

Indian Register of Shipping (IRS) to provide Quality Assurance services for a refit of the Indian Navy's submarine, INS Sindhukirti

IRS has secured an order for providing Quality Assurance (QA) services for an Indian Navy submarine during refit. IRS shall undertake quality inspections of the Hull, Machinery and Electrical systems on board the submarine in accordance with the approved QA plan.

Indian Register of Shipping (IRS) selects Dassault Systèmes to drive digital transformation and boost efficiency

IRS has entered into a collaboration with Dassault Systèmes to leverage virtual twin technology which involves the use of Dassault Systèmes' 3DEXPERIENCE platform to optimize the performance and efficiency of complex marine and offshore projects.

For details, visit - <https://www.irclass.org/media-and-publications/news/>

Events, Webinars & Conferences

Indian Register of Shipping (IRS) highlights maritime services and forges stronger relationships at Singapore Maritime Week 2023



IRS organised several successful events and took part in industry activities during Singapore Maritime Week (SMW) 2023 (April 24-28). IRS hosted its 6th Singapore Advisory Committee Meeting as well as Customer Meet apart from a booth presence in the Sea Asia exhibition.

Consultants & Shipyards Meet, 28th April 2023

IRS organised a 'Consultants and Shipyards Meet' at its Head Office in Mumbai which was well attended by maritime representatives and covered several presentations followed by an interactive Q&A session.



IRS relocates to New Premises in Jamnagar and Kandla



To serve the business expansion needs and to strengthen the growing business opportunities, IRS has shifted to new premises in Kandla and Jamnagar. The new office inauguration was attended by key maritime professionals.

IRS participation in conferences & seminars -

11th Finance Transformation India Summit & Awards - 21st July 2023

Mr. Vinay Kshirsagar spoke on 'Opportunities posed to the Finance function of taking a leadership position in the development of ESG policies and framework'.



Seminar on “Shaping the Future of Indian Shipping: Wartsila Seminar on Strategies and Innovations for Decarbonisation” - 20th June 2023

Mr. P. K. Mishra, Head of Operations shared his views on 'Decarbonisation: Opportunity & Challenges for Indian Shipping'.



Conference on ‘Classification Regulations and Advanced Technologies for Naval Ships and Auxiliaries’ - 27-28 Jun 2023

IRS Subject Matter Experts spoke on the below subjects at the conference organised by Naval HQ -



- Cdr. KK Dhawan (Retd), Head of Defence - Genesis of Naval Ship Classification.

- Mr. R. Srinivas, VP - Remote Control Centres for Autonomous Vessels



- Mr. Sharad Dhavalikar, Principal Surveyor - Plume Dispersion and Infrared Signature Analysis.

ASEAN Regional Forum Training Series - 11-12 April 2023

- Mr. Amit Bhatnagar, Head IRClass Academy shared his expertise on the 'ISPS Code on Port Facility Security & Implementation of Container Security Initiative'.



- Mr. Avinash Vaze, Senior Surveyor spoke on 'Cyber Security Initiatives India'.

Skilling up the Maritime sector in the world of Digitalization by CMMI - 28th June 2023

Mr. R. Srinivas, VP shared his insights at the panel discussion on subtheme 'Impact on Related Sectors and Skilling Needs'.

MARPOL at 50 - Our Commitment goes on - 25th June 2023

Ms. Megha Sharma, Surveyor spoke on 'Seafarer's Contribution for Protecting Oceans' at the 'Day of the Seafarer' Celebration event organised by the National Maritime Day Celebration (central) Committee (NMDC).

For details, visit - <https://www.irclass.org/media-and-publications/events/>

Vessels – Classed, Launched & Delivered

Six Next Generation Missile Vessels (NGMVs) being classed by the Indian Register of Shipping

IRS is proud to announce that it will provide classification services and certify six Next Generation Missile Vessels (NGMVs) to be constructed at Cochin Shipyard Limited (CSL).

Indian Register of Shipping classed Indian Navy warships launched

IRS is pleased to announce that two new vessels for the Indian Navy, the last of the series of four Survey Vessels (Large) [SV(L)], INS Sanshodak, and the third in the series of eight Anti-Submarine Warfare Shallow Water Craft [ASW-SWC], INS Anjadip, were launched on 13th June 2023. The keel for the seventh ASW-SWC was also laid on the same day.



M.V. SIDDHIVINAYAK-I
Bulk Carrier
Jaydeep Associates Pvt. Ltd.



VRAJ SAGAR
General Cargo Ship
Shreeji Shipping Services
(India) Ltd.



APCO GANGA 1
Jackup Barge
M/s Apco Infratech Private Ltd.



M.V. SIKHA-II
Bulk Carrier
Danaos Ship Management Pvt. Ltd.



AKSHAR RIVER CRUISE
Passenger Ferry
Akshar Travels Pvt. Ltd.

For details, visit - <https://www.irclass.org/media-and-publications/news/>

Training for Campus Recruit Engineers

In continued pursuit of improving the quality of our performance, which has to start with our Surveyors who are our primary asset, an upfront three-month familiarisation training has been introduced for Naval Architects and Marine Engineers recruited from various reputed institutes pan India. This three-month training programme is developed with a view to handhold the graduates from their campus life to the classification society career. This will aid to bridge the gap between their respective curriculum as well as enhance their overall perspective required for a classification society Surveyor. The first batch of 24 young graduates, comprising of Naval Architects and Marine Engineers joined our Head Office on 3rd July.

The programme covers HR orientation, one month of classroom training followed by two months of hands-on practical training on Hull, Machinery & Electrical plans and its approval process. The engineers are assessed regularly for each topic during the classroom sessions. They are evaluated by dedicated mentors during the practical sessions. On completion of the training, these engineers turned Surveyors will be posted to different departments in HO as well as Survey Stations and continue on to qualify for the respective field of activity. This initial training and the familiarisation is sure to start off their careers at IRS on a positive note.



Completed Training

IRS Head office witnessed the second Classroom Induction Training this year, which was held from 10th-21st July 2023. Amidst the other regular topics, three sessions were introduced on 'Online

Reporting Systems', which was held in a hybrid mode enabling Surveyors from both domestic and international Survey Stations to attend the same concurrently.



Training for Surveyors from Kenya Maritime Authority

The second semester out of the eight semesters for the Kenya Maritime Surveyors has commenced from July 2023. Three of them are continuing at HO with the Plan Approval training/qualification whereas two Surveyors who were at Kochi SS have been sent to Goa SS to continue with their SS training programme. This semester will continue till Dec 2023.

Practical training for PAC Surveyors

A two-week training at Survey Station for PAC Surveyors was completed in August 2023. Seeing the usefulness of this training, four Surveyors from the Research and Development department also were included in this training. The training was conducted in four batches each at Kochi, Vizag and Goa Survey Stations. The trainees are introduced to different activities at Survey Stations, shipyards, new construction, ships in service, marine components, etc.

Online Training Sessions

Various online training sessions were carried out including sessions on upcoming changes or new requirements in IMO/IACS/Class Rules, EEXI, Alternate Fuels, Autonomous Vessels, Fuel cells, BioFuels, LNG carriers, etc. As an additional facility, these training sessions were also recorded and made available online.





IRClass Academy conducted a large number of value-added training programs which received significant participation and positive response from the maritime industry professionals.

The Academy offered a customised training program on the handling of IMDG Cargo in Port, which was well received by the industry.

The Academy signed an MoU with Rashtriya Raksha University, Ahmedabad. Under the terms of the MOU, both IRClass Academy and RRU will develop a series of specialised courses which will

be conducted at RRU. The courses will cater to Company Security Officers (CSOs), Ship Security Officers (SSOs), Port Facility Security Officers (PFSOs) and seafarers with designated security duties. In addition, both IRClass Academy and RRU have jointly decided to offer additional courses, customised to the needs of various maritime security agencies and industries.

The Academy also conducted a training program for the structural, machinery & electrical designers of the Cochin shipyard at their premises in Kochi.



The 9th batch of 2-week Coast Guard personnel training concluded on 30th June 2023. The valedictory function was attended by many senior officers from the Coast Guard Western Seaboard & Regional Headquarters (West).

For Upcoming courses, visit - <https://www.irclass.org/academy/scheduled-courses>

Employee Corner

Promotion from Senior Principal Surveyor (SPS) to Chief Surveyor (CS)



Dr. Asokendu Samanta
(DH, Research & Development)



Mr. Rajeev Pratap Rao
(RM, Middle East & Africa
and Europe & Americas)

Principal Surveyor to Sr. Principal Surveyor (SPS)



Mr. Shammy K.
(SPS & RM - South West
Coast of India & SEA)



Mr. Saikat Roychowdhury
(SPS & RM - East Coast of
India & Bangladesh)



Cdr. Amitabh Dube
(SPS - Plan Approval
Centre, Hull)



Elevation to Divisional Head

Dr. Suman K. Jha, Vice President
Elevated to the position of Divisional Head,
HR & Administration.

Yoga Day



IRClass celebrated International Yoga Day on 21st June 2023 at HO. The event began with a brief introduction on Yoga Day by Mr. Vasudev Nair & Dr. Rashmi Muraleedharan, Yoga Representatives for The Sadhak' of MAASHREE'S UTTARANN.

Warm-up exercises were conducted and employees enthusiastically practised & performed asanas, whilst the instructors explained the importance of the asanas simultaneously.

The session was concluded with a vote of thanks to Mr. Vasudev Nair & Dr. Rashmi Muraleedharan for their valuable presence and support. It is anticipated that this celebration will inspire more employees to embrace yoga in their lives.



Blood Donation



IRS conducted a blood donation drive on 2nd June 2023 at its H.O., Mumbai. Employees who volunteered & donated towards this noble cause received certificates of recognition.



Independence Day



IRClass gathered to celebrate Independence Day, 15th August 2023. The event was filled with festive spirit and engagement of employees with vibrant tricolour theme and fun-filled games.



Everest Base Camp Trek

Cdr. Amitabh Dube, Sr. Principal Surveyor successfully completed the rigorous two-week trek to Everest Base Camp on 17th May 2023, which symbolised the indomitable human spirit and the triumph of perseverance.



Ultra Marathon 2023

Mr. Bijay Nair, IRClass Systems and Solutions Pvt. Ltd. completed the 89 km 'Comrades Ultra Marathon 2023', at South Africa within 12 hrs. Popularly known as 'The Ultimate Human Race'- it is a true test of human endurance, grit & determination. This being his second successful completion of the Ultra Marathon after completing in 2019, makes it even more special.



Sad Demise

Our deepest condolences to friends and family of Mr. Anand Sankar and Mr. Manish Panchal. They will be missed.



Mr. Anand Sankar M
(21/09/1994 - 08/06/2023)



Mr. Manish Panchal
(13/2/1995 – 26/5/2023)



YOUR PARTNER IN MARITIME RISK MANAGEMENT



-  MARINE
-  OFFSHORE
-  DEFENCE
-  RESEARCH & DEVELOPMENT
-  MARINE TECHNICAL SERVICES
-  INDUSTRIAL
-  MANAGEMENT SYSTEMS CERTIFICATION
-  EDUCATION & TRAINING



IRCLASS
Indian Register of Shipping

Head Office:
52A, Adi Shankaracharya Marg, Opp. Powai Lake,
Powai, Mumbai - 400 072, India
Email: ho@irclass.org
Web: www.irclass.org
Tel: +91 22 3051 9400 / +91 22 7119 9400